



Elements

Simplified security for
your changing world.



Introducing LenelS2 Elements



Security in its simplest form

The LenelS2™ Elements™ solution is a comprehensive, easy to use unified access control and video management solution built for the cloud. From single-site access control and video surveillance to more complex solutions, the Elements solution contains all the key ingredients for an effective and scalable, cloud-based solution; providing savvy businesses with a brand-new security option that is as simple as it is essential.



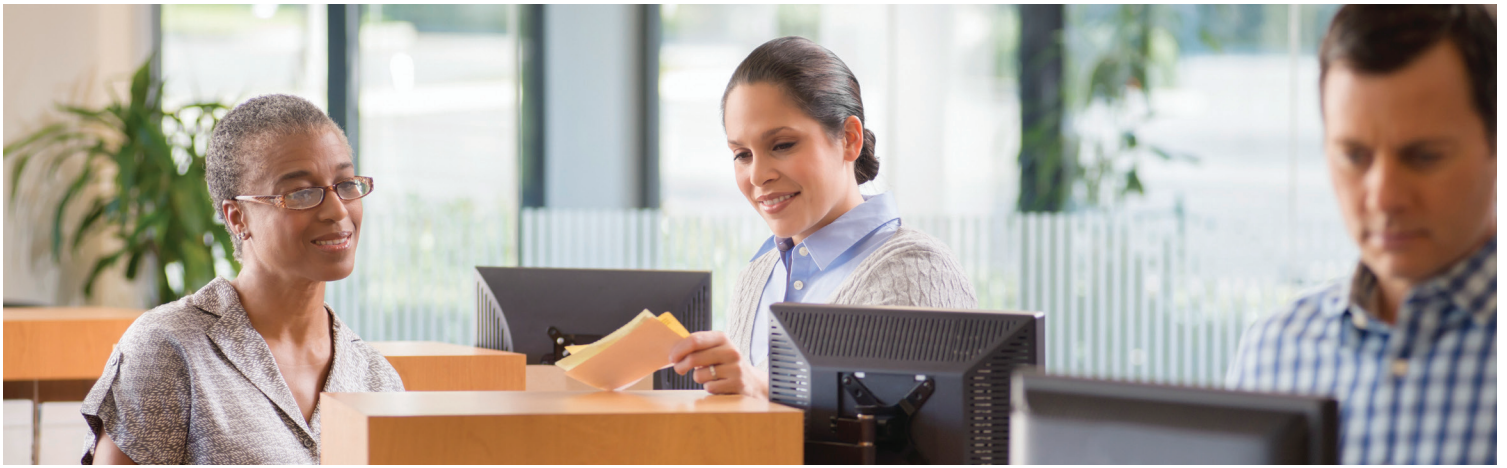

Easy, mobile, scalable, unified

Ea
Easy

The Elements solution is a flexible, intuitive, and effective security option. It helps make spaces where you live, work, and thrive more secure, easier to manage and was developed by the same industry-leading company that protects some of the world's largest enterprises. Small- to medium-sized businesses and enterprise organizations with satellite offices can benefit from leveraging the power of the cloud to simplify their system setup, ensure predictable costs and manage their security with fewer resources all while minimizing installation time, training and the high-costs it takes to acquire and maintain advanced security.

Mo
Mobile

The Elements solution is mobile-first and browser-based. Information is available at any time and easily accessible from anywhere, on any device. Elements mobile capabilities also simplify the onboarding process and enable the ability to remotely grant access, view video, or lock doors. For small- to medium-sized businesses and satellite offices, the flexibility to access security information and take actions on-the-go is critical.

Sc
Scalable

Available as a standalone solution or one that integrates seamlessly with the OnGuard® access control system. A leading solution for enterprise businesses, the Elements solution provides growing businesses with a simple, expandable security solution that fits their ever-evolving needs. Leveraging the cloud, the solution can scale to power security deployments of any size.

U
Unified

The Elements solution empowers organizations with a unified, cloud-based access control and video management experience. The Elements web portal enables a unified video and access control experience providing system configuration, real-time video verification of alarms and events, and viewing of recorded video in a single user interface. Plug-ins or extra software are not required for the system, allowing access from any device to monitor your organization while at the office or on the go.

In your Element

The Elements security solution is perfect for cloud-first organizations and those with limited IT resources, business or satellite locations that need secure workplaces but may not have permanent IT staff or security professionals. Easy to run and maintain, the Elements solution provides hassle-free, effective security that allows businesses to focus on more important things — like running their business. Updates and enhancements are pushed in real time reducing costly site visits, making budgeting more predictable, and keeping capital expenses down. Mobile-first, the solution can be accessed at any time, from anywhere. As the only unified access control and video management solution that integrates with the OnGuard security management platform, the Elements solution can expand to meet the needs of a business as it grows. As your business grows and requires enterprise-level functionality, you can rest assured that Elements will grow with you.



Small- and medium-sized businesses



Professional offices

Implement security at predictable monthly costs and manage with fewer resources.



Property management companies

Secure multi-tenant buildings of any size.



Small business owners

Cloud-based, scalable security that can grow alongside your business.



K-12 Education

Lock doors from anywhere, on any device.

Medium-to-large organizations with satellite offices



Remote sales offices

Built mobile-first to complement a mobile workforce.



Field support locations

Automatic updates from the cloud lets you focus on what matters most: your people.



Branch offices

Extend enterprise level security to branch offices with the OnGuard Connector.



Health system satellite locations

Simple, effective and intuitive security to keep satellite healthcare centers/locations safe.

New user experience, familiar hardware

The Elements web portal – the user interface – is designed to be simple and immediately intuitive for users of any background. Separate web portals are available for Value-Added Resellers (VARs) and end users enabling a managed or self-managed solution.

Simple & intuitive user experience



Mobile-friendly

The web portal is mobile friendly on any platform or device. The user interface will scale automatically for convenience.

Mobile credentials

A smart alternative to plastic badges, mobile credentials enabled through the BlueDiamond™ mobile app offer convenience without compromising security.



Guest Pass



Issue temporary access to people without needing to issue physical badges or downloading and registering mobile apps.

Introducing 'Spaces'

Focus on securing the spaces you care about instead of utilizing complex security models.



Event monitoring



Easily interact and monitor the Elements system from anywhere.

Video monitoring

Connect to an EVR, direct-connect to cameras with SD cards, and/or to an existing Milestone XProtect recorder.



Access management



Management of access control is made simple and convenient through the web portal.

Mobile credential management

The web portal simplifies the process for issuing mobile credentials through its intuitive design and mobile-friendly approach.



Real-time hardware events



Easily interact and monitor the system from anywhere.

Command and control

Grant temporary access or lock a door from a mobile device.

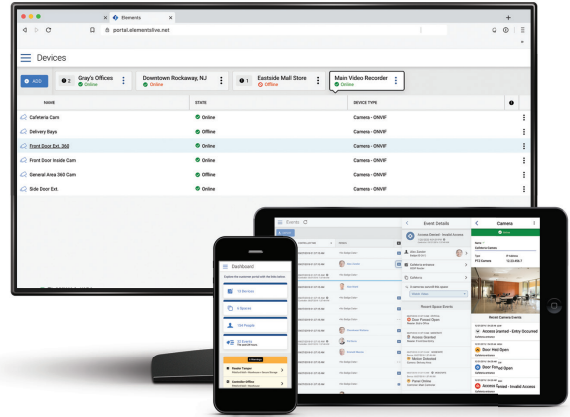

Hardware support*

The Elements cloud-based solution integrates with the hardware you know and fits seamlessly into the LenelS2 ecosystem of products.

Hardware

The Elements Cloud access control solution supports both our proprietary Network Node and non-proprietary Mercury hardware offering multiple deployment configurations and options.

Elements Video Recorder

Designed specifically for the Elements system, the Elements Video Recorder supports up to 16 IP ONVIF® Profile T cameras per recorder with up to 8TB of on-premise video storage.



BlueDiamond readers

BlueDiamond readers provide a feature-rich reader platform with support of all modern security protocols, a wide range of smart cards and mobile credentials.



Wiegand/OSDP™ readers

The system supports readers featuring Wiegand, OSDP and OSDP Secure Channel protocol.



*For a full list of compatible hardware, please refer to the Elements solution data sheet or the Elements video recorder data sheet.

Deployment Models

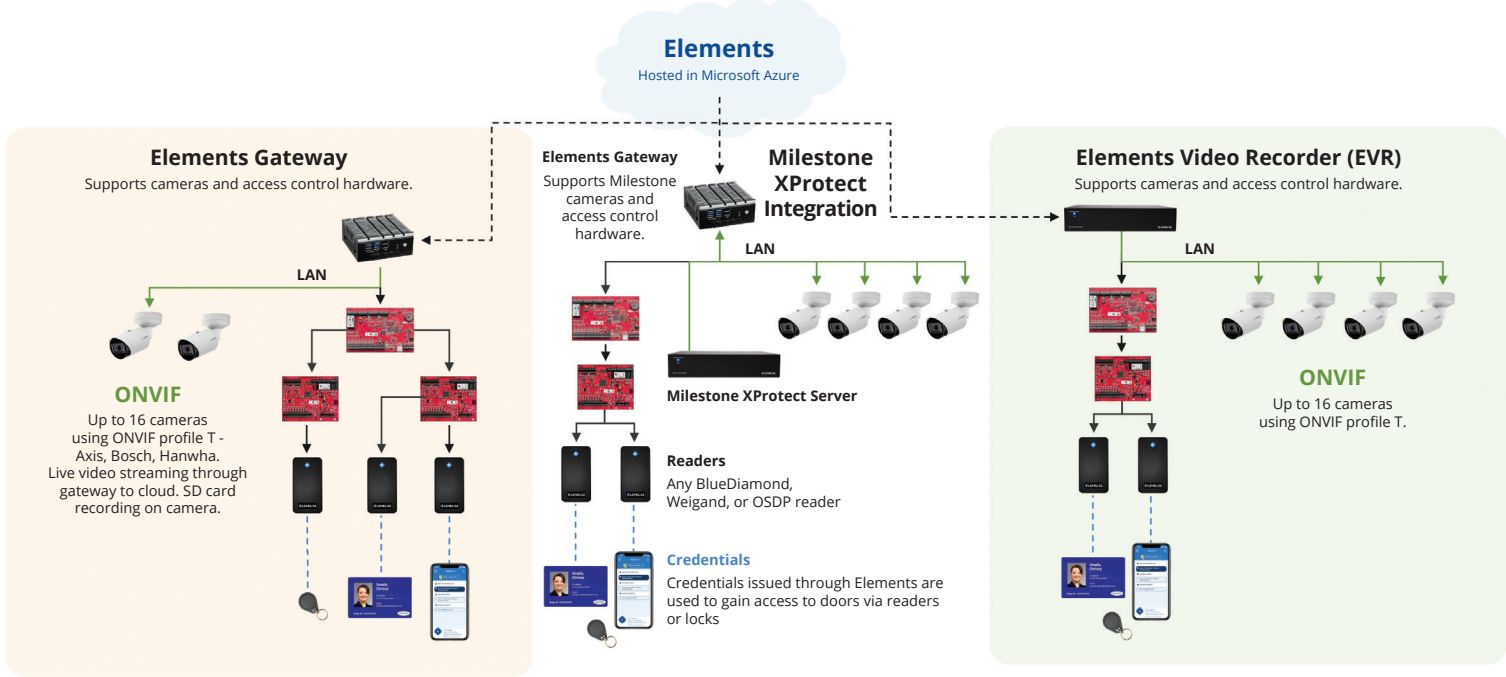

Enterprise Ready

For small- to medium-sized businesses the Elements solution offers a unified, full-featured, standalone and cloud-based access control and video management solution. But for enterprises, the solution provides the Elements OnGuard Connector which enables the OnGuard access control system to seamlessly communicate with the Elements cloud. The OnGuard Connector provides enterprises with the flexibility to run the on-premise OnGuard system at its headquarters while satellite offices or branches are secured by the Elements solution.

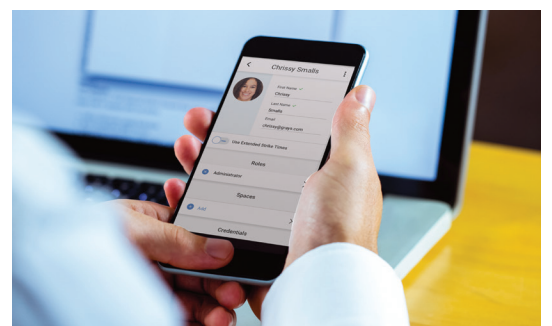
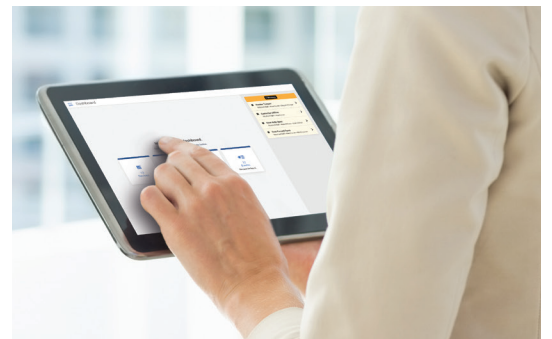
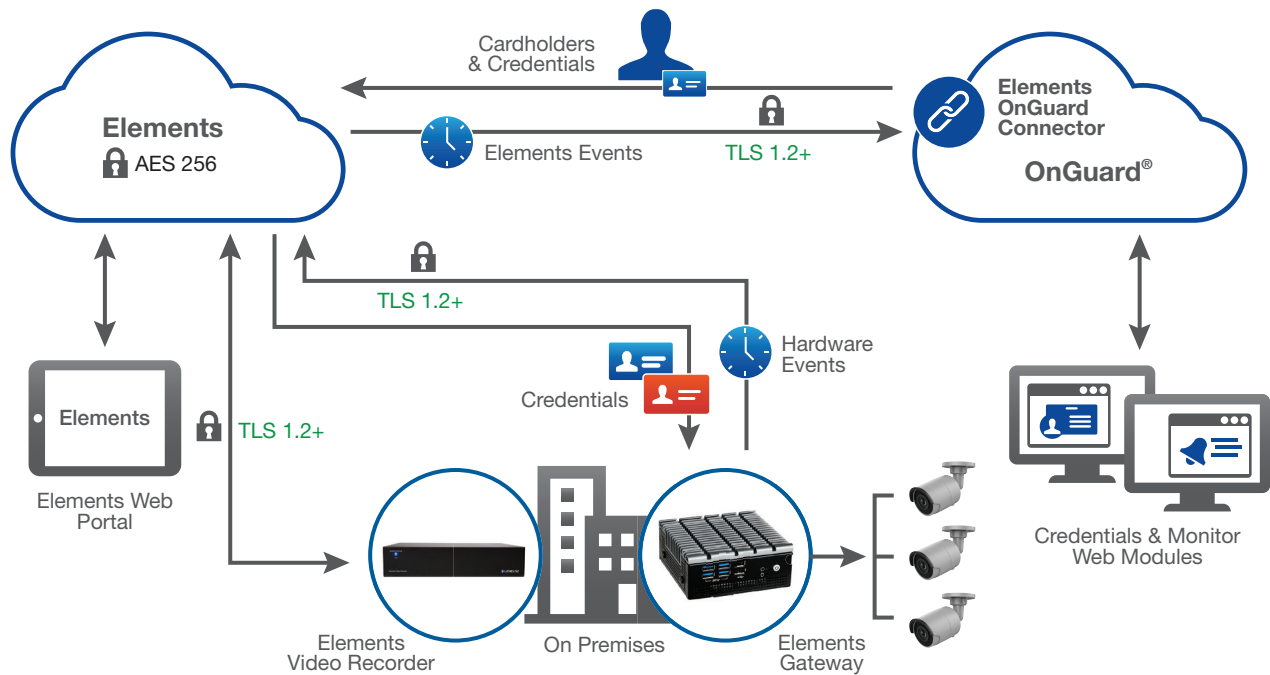

The Element of (Cyber)Security & Privacy

The Elements solution was built with “Privacy by Design” security principles and is secured through end-to-end encryption. Users can be assured that all connections between the Elements Gateway and the cloud use industry-standard encryption and, since all traffic is initiated from on-site devices, no inbound ports need to be opened in your network security firewall.

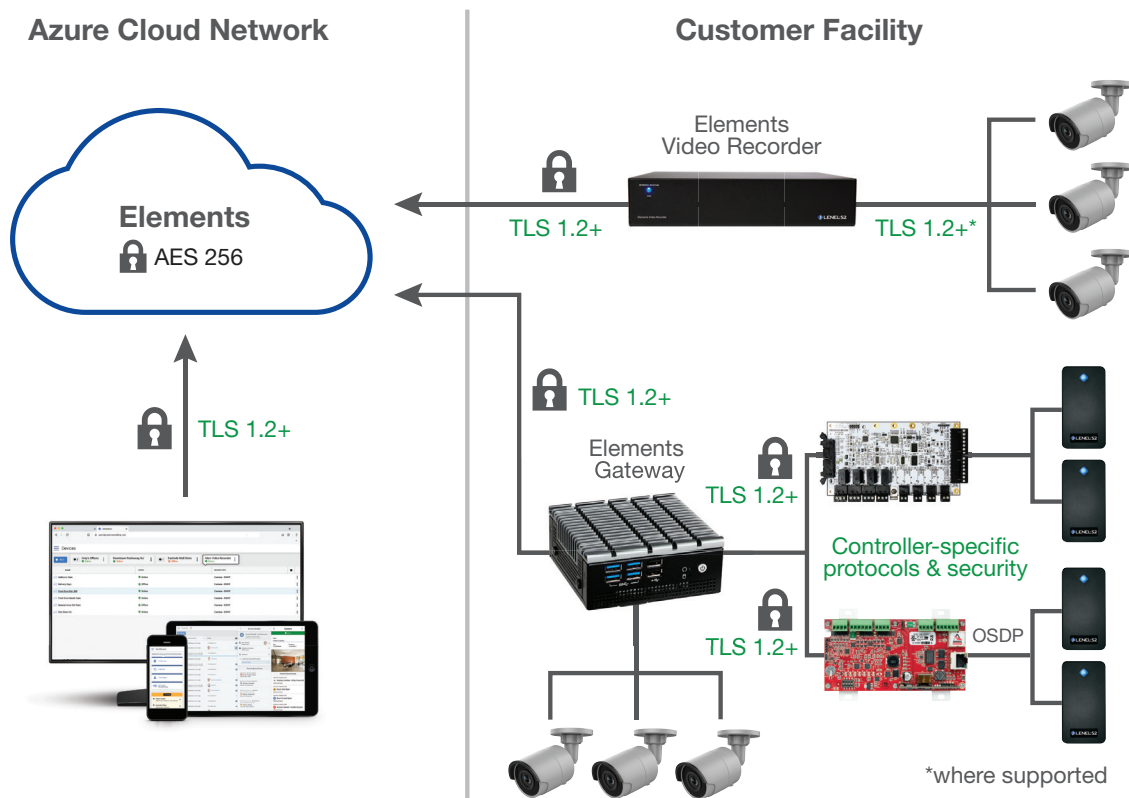

LenelS2 is a global leader in advanced physical security solutions, including access control, video surveillance and mobile credentialing. Our technology includes web-based and mobile applications enhanced by cloud-based services. Incorporating open architecture, LenelS2 provides scalable, unified security management solutions to customers ranging from global enterprises to small- and mid-sized businesses. Easy to install and use, LenelS2 products are supported by an experienced, responsive team dedicated to providing exceptional service. LenelS2 serves segments worldwide including corporate, education, healthcare and government.

[LenelS2.com](https://www.LenelS2.com)

(866) 788-5095

Specifications subject to change without notice.

© 2024 Honeywell International Inc. All Rights Reserved. All trademarks and service marks referred herein are the property of their respective owners. 2024/04